

FS-PND+ insert

compatible with Pandemic: Iberia[®],
Pandemic: Fall of Rome[®], or Pandemic: Rising Tide[®]



Assembly Instructions

The package contains 2 sheets.

After assembly the trays are put in a single layers in the original game box.

Ordinary PVA glue is required when assembling each tray.

Please make sure you dry-assemble each tray correctly before gluing it together.

Please check www.foldedspace.net for general assembly tips.

Note that Tray 1 and Tray 2 have dividers on the top and bottom of the tray.

FS-PND+

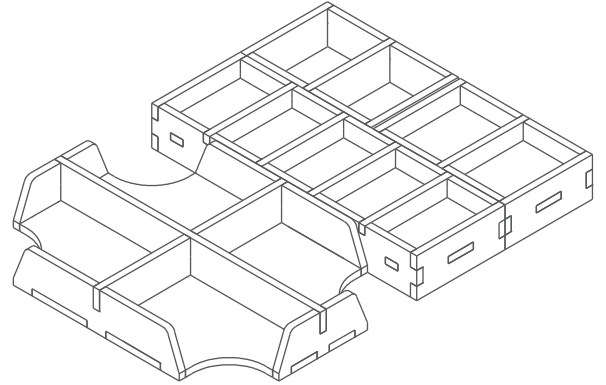

Sheet A1

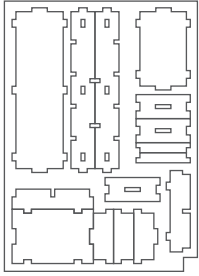

Sheet B1

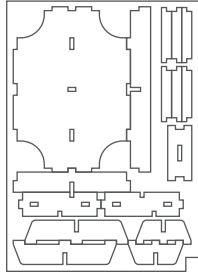

Tray 1: please take particular care to use the correct dividers and end pieces as they are different to those in Tray 2

Sheet A1

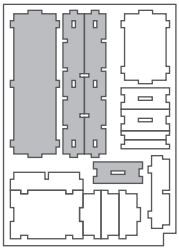

Sheet B1

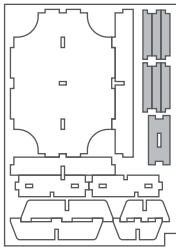

Step 1

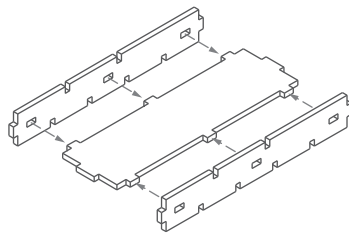

Step 2

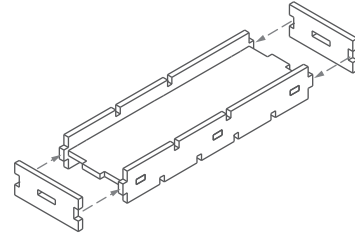

Finished tray

Step 3

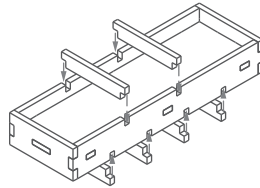

Finished tray

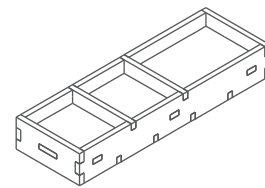

Tray 2: please take particular care to use the correct dividers and end pieces as they are different to those in Tray 1

Sheet A1

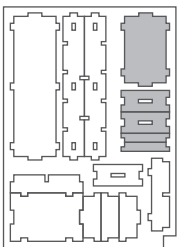

Sheet B1

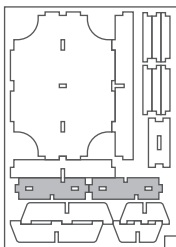

Step 1

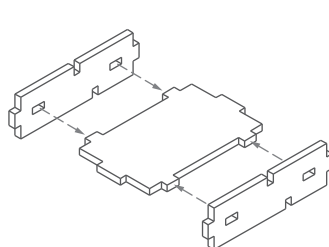

Step 2

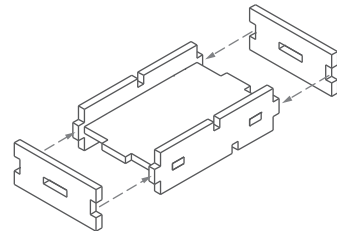

Step 3

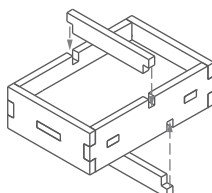

Finished tray

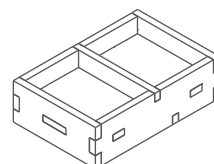

Tray 3

Sheet A1

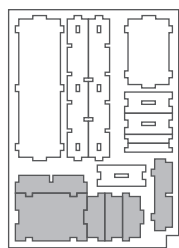

Step 1

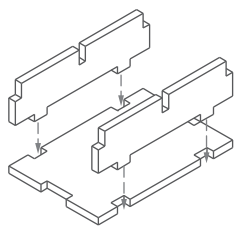

Step 2

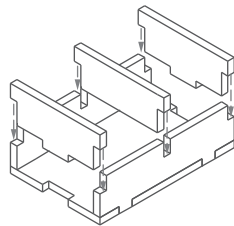

Finished tray

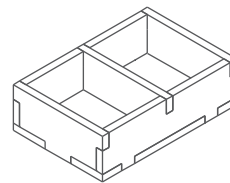

Tray 4

Sheet B1

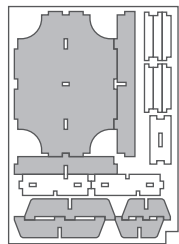

Step 1

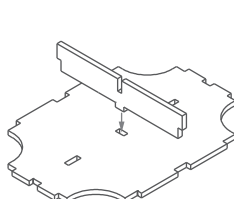

Step 2

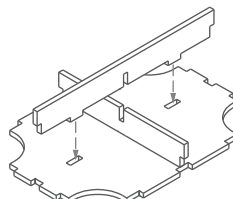

Step 3

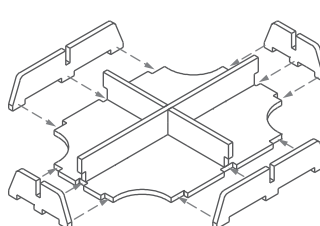

Finished tray

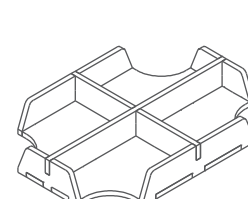

FS-PND+

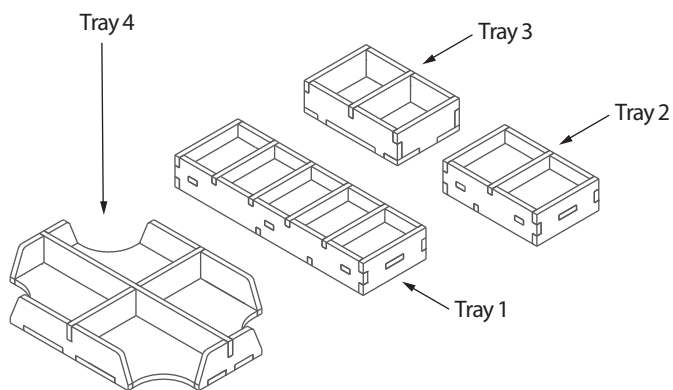

PANDEMIC: IBERIA®

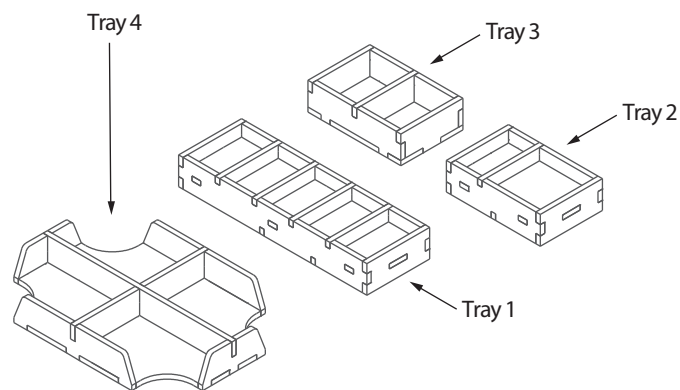

PANDEMIC: FALL OF ROME®

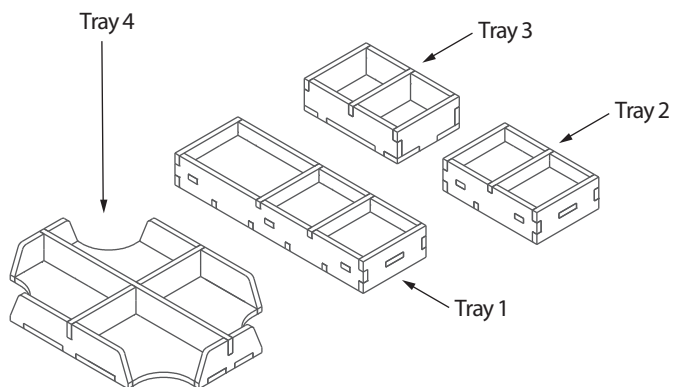

PANDEMIC: RISING TIDE®

Tray legend Iberia:

- Tray 1 - disease cubes and hospitals & research markers
- Tray 2 - purification and railroad tokens
- Tray 3 - pawns and other markers
- Tray 4 - cards

Tray legend Fall of Rome:

- Tray 1 - barbarian cubes
- Tray 2 - legions and forts
- Tray 3 - pawns & dice, and other tokens
- Tray 4 - cards

Tray legend Rising Tide:

- Tray 1 - water & population cubes, and dikes
- Tray 2 - ports and pumping stations
- Tray 3 - pawns and other markers
- Tray 4 - cards

Please check www.foldedspace.net for photos of this insert in use.

Tip: Keep the instructions in the bottom of your board game box as a reminder of how the insert fits together.