

FS-WINGv2 insert compatible with Wingspan[®], incl. the European[®] and Oceania[®] expansions

Assembly Instructions

The package contains 4 sheets, two identical to each other and two different sheets.

After assembly the trays are put in three layers in the original game box.

Ordinary PVA glue is required when assembling each tray.

Please make sure you dry-assemble each tray correctly before gluing it together.

Please check www.foldedspace.net for general assembly tips.

FS-WINGv2

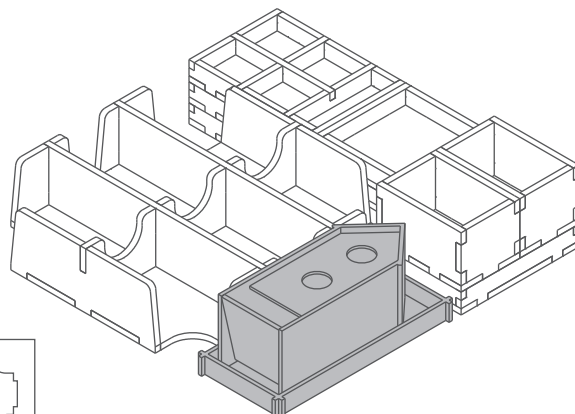

Sheet A1

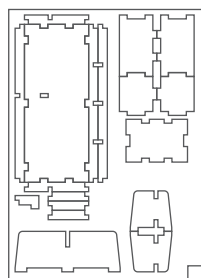

Sheet A2

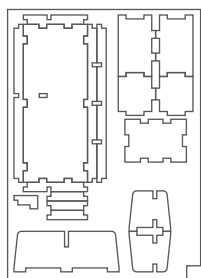

Sheet B

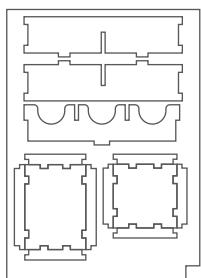

Sheet C

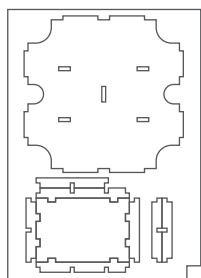

Tray 1a & 1b (the trays are identical)

Sheet A1

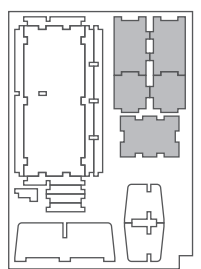

Sheet A2

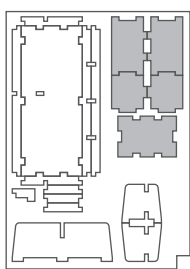

Step 1

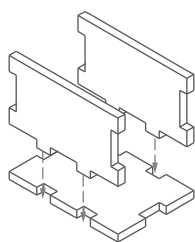

Step 2

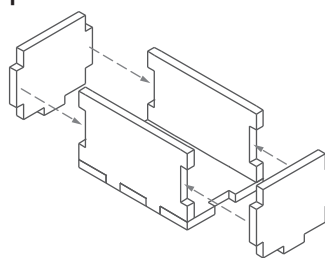

Finished tray

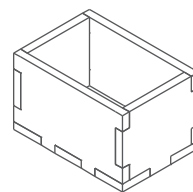

Tray 2

Sheet B

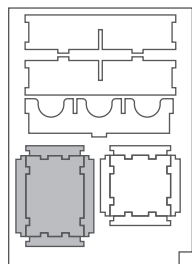

Step 1

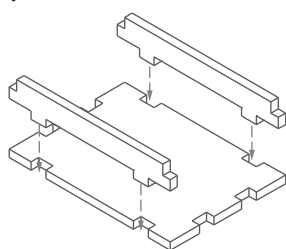

Step 2

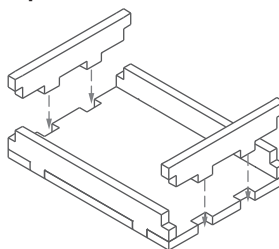

Finished tray

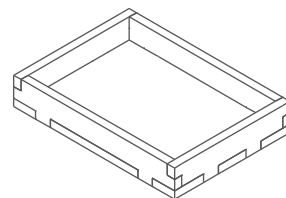

Tray 3

Sheet B

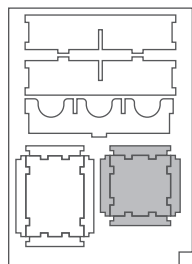

Step 1

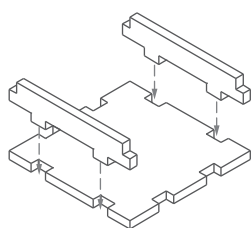

Step 2

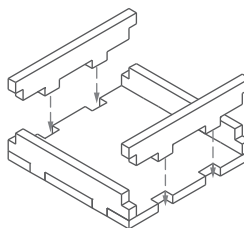

Finished tray

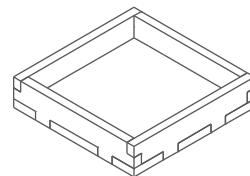

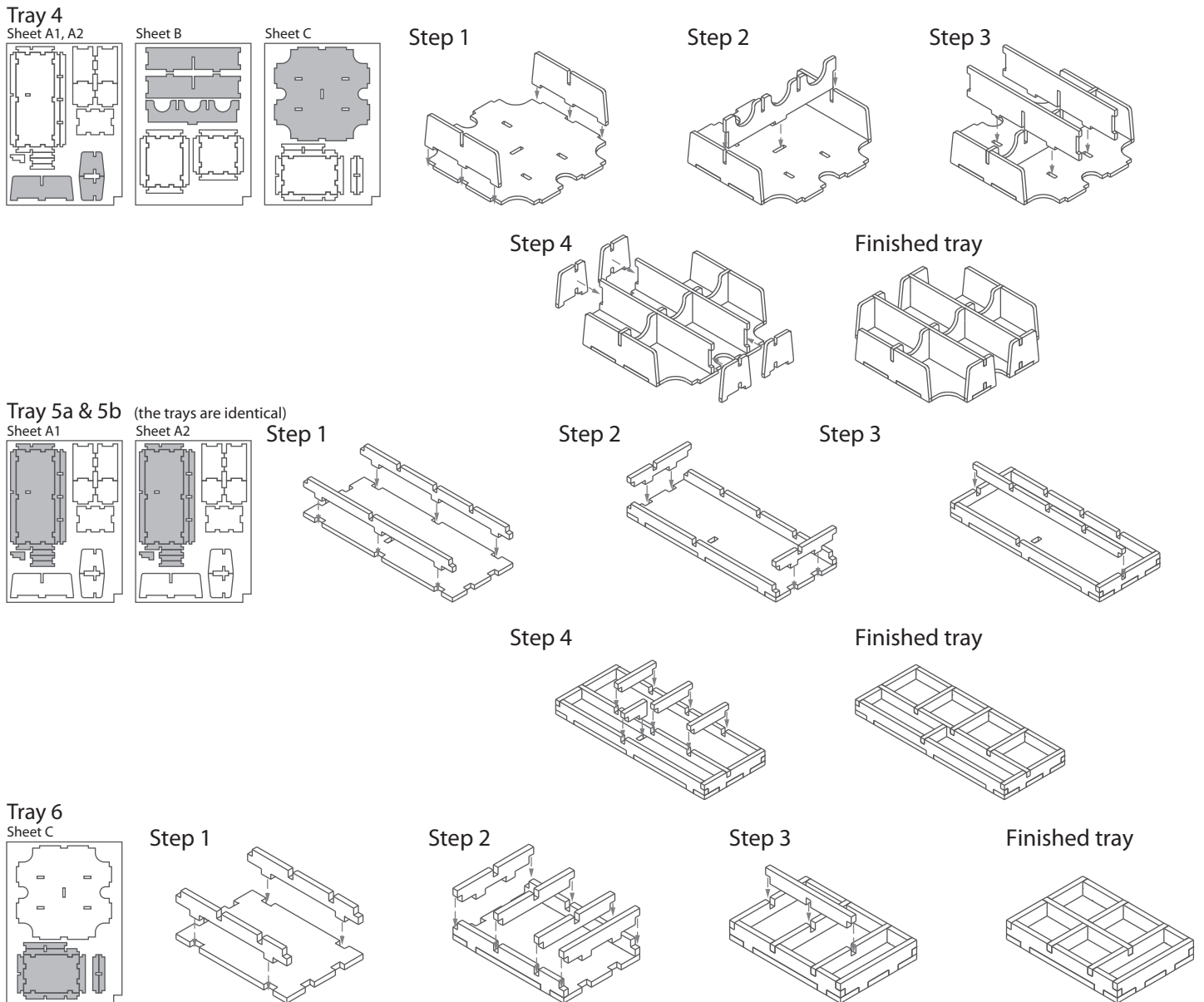

FS-WINGv2

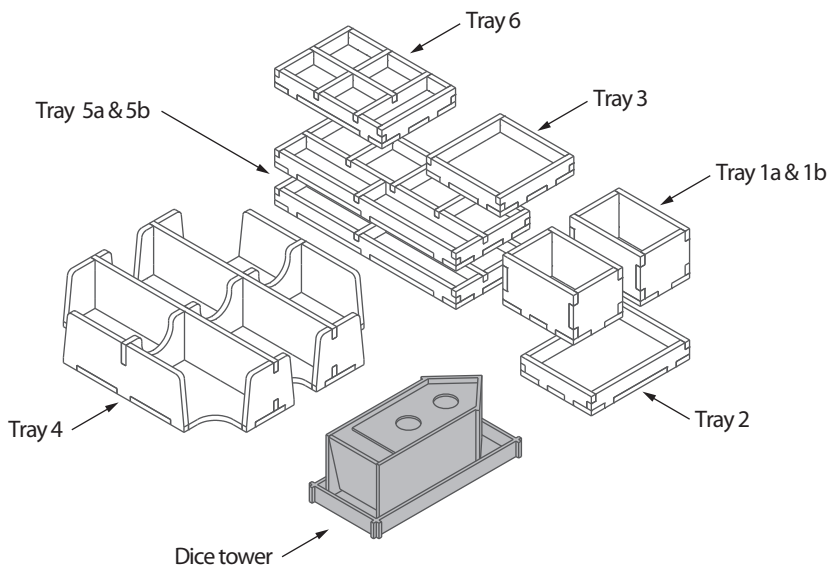

Please check www.foldedspace.net for photos of this insert in use.

Tray legend:

- Tray 1a, b - eggs
- Tray 2 - excess nectar tokens
- Tray 3 - goal tiles
- Tray 4 - cards
- Tray 5a, b - food tokens
- Tray 6 - player action cubes

Note: the 10 dice are placed inside the dice tower. There is space for only one set of player mats, either those form the base game or the Oceania ones. The second set should be stored separately in the Oceania box. Note also that there is room for only one score pad, which is placed on top of Trays 1a, b.