

FS-RDSCY insert compatible with Raiders of Scythia®



Assembly Instructions

The package contains 3 sheets, two identical and one different sheet.

The part marked in sheet A2 is to be discarded.

After assembly the trays are put in two layers in the original game box.

Ordinary PVA glue is required when assembling each tray.

Please make sure you dry-assemble each tray correctly before gluing it together.

Please check www.foldedspace.net for general assembly tips.

FS-RDSCY

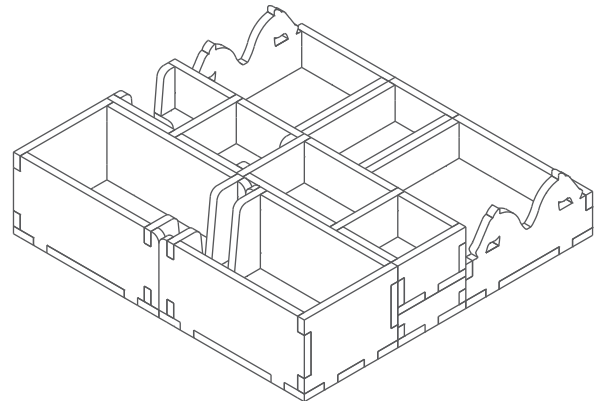

Sheet A1

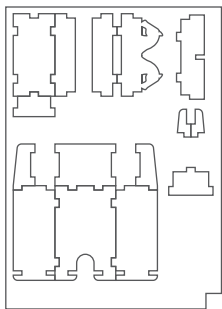

Sheet A2

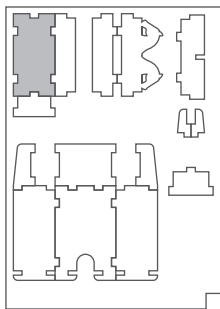

Sheet B1

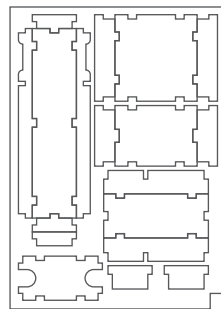

Tray 1

Sheet A1

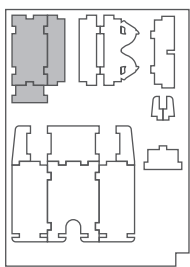

Sheet A2

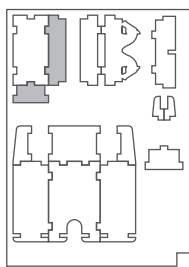

Step 1

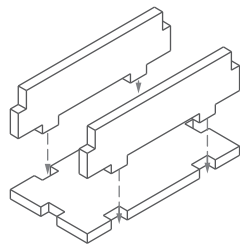

Step 2

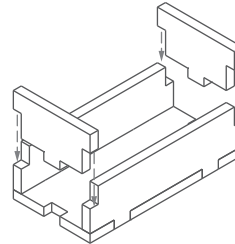

Finished tray

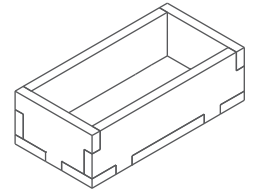

Tray 2

Sheet A1, A2

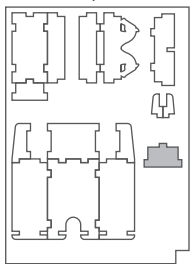

Sheet B1

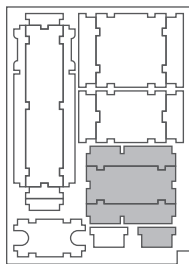

Step 1

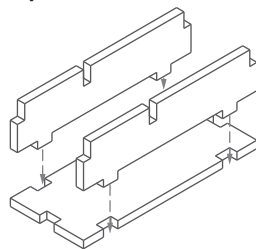

Step 2

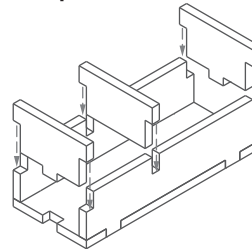

Finished tray

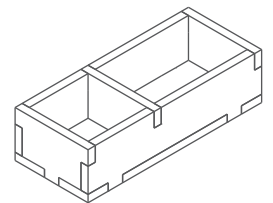

Tray 3a & 3b

(the trays are identical)

Sheet A1

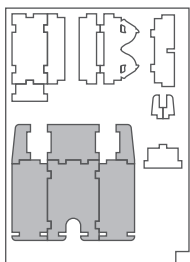

Sheet A2

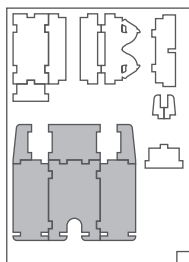

Step 1

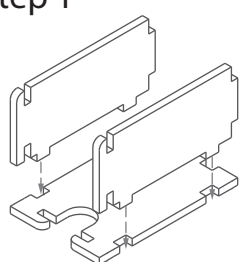

Step 2

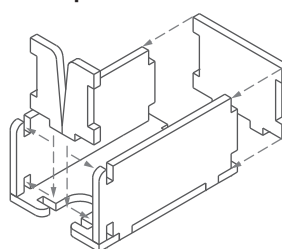

Finished tray

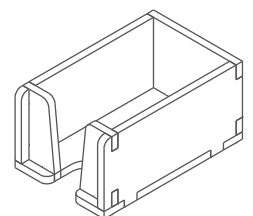

Tray 4

Sheet A1, A2

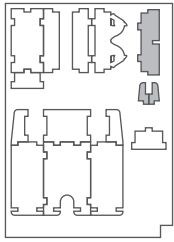

Sheet B1

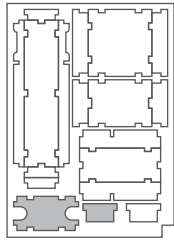

Step 1

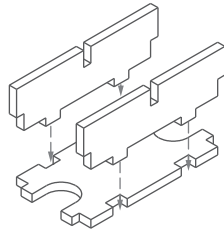

Step 2

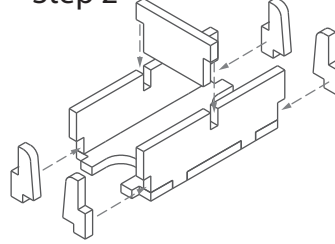

Finished tray

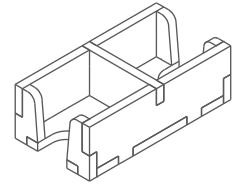

Tray 5a

Sheet A1

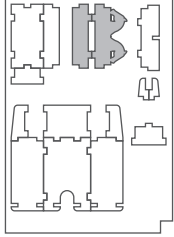

Sheet B1

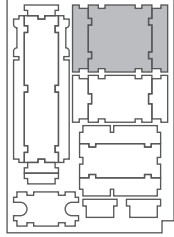

Step 1

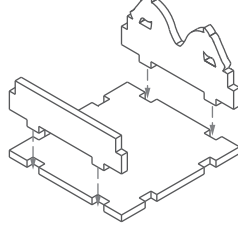

Step 2

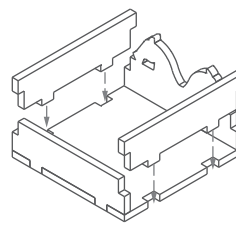

Finished tray

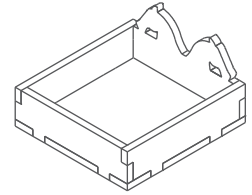

Tray 5b

Sheet A2

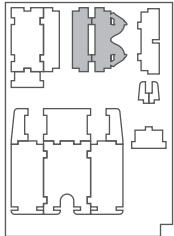

Sheet B1

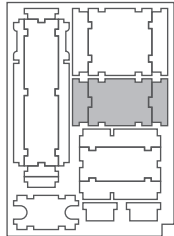

Step 1

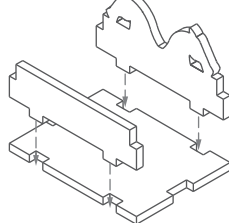

Step 2

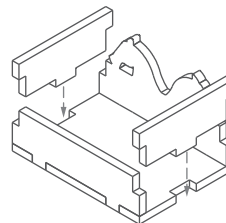

Finished tray

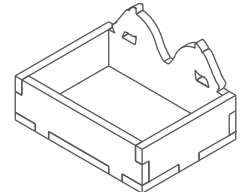

Tray 6

Sheet B1

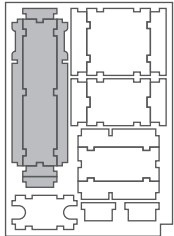

Step 1

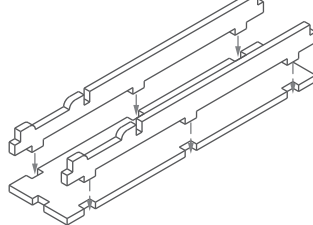

Step 2

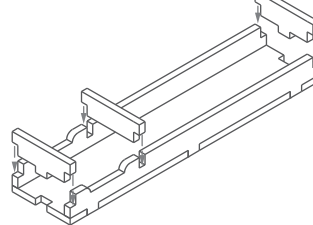

Finished tray

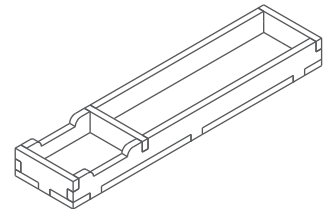

FS-RDSCY

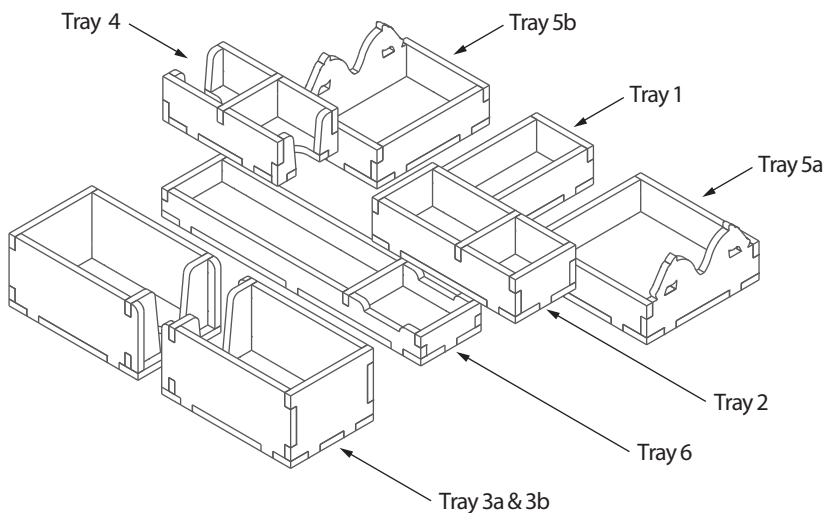

Please check www.foldedspace.net for photos of this insert in use.

Tray legend:

- Tray 1 - silver coins
- Tray 2 - kumis and wound tokens
- Tray 3a - other cards
- Tray 3b - crew cards
- Tray 4 - quest tiles
- Tray 5a - plunder tokens
- Tray 5b - workers
- Tray 6 - provisions and dice & score markers

Note: the player boards are placed on top of Trays 1 & 5.