

Assembly Instructions

The package contains 6 sheets: three double sheets.
 After assembly the trays are put in two layers in the original game box.
 Ordinary PVA glue is required when assembling each tray.
 Please make sure you dry-assemble each tray correctly before gluing it together.
 Please check www.foldedspace.net for general assembly tips.
 The parts marked in sheet B2 and C1 are to be discarded.

FS-ARNO

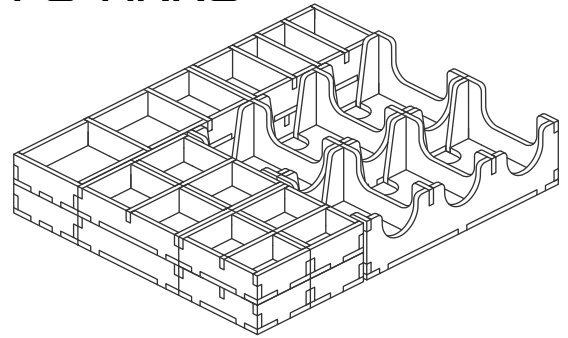

Sheet A1

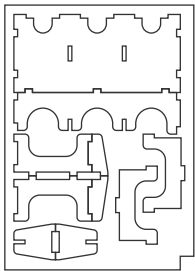

Sheet A2

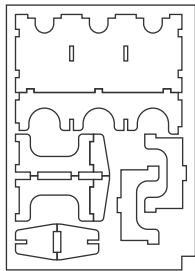

Sheet B1

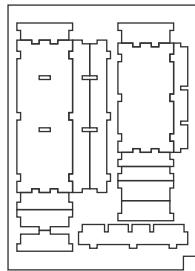

Sheet B2

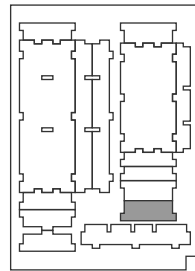

Sheet C1

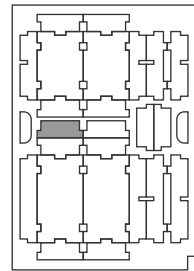

Sheet C2

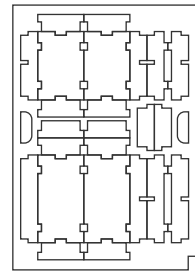

Tray 1a, 1b

(the trays are identical)

Sheet B1, B2

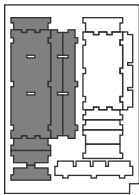

Step 1

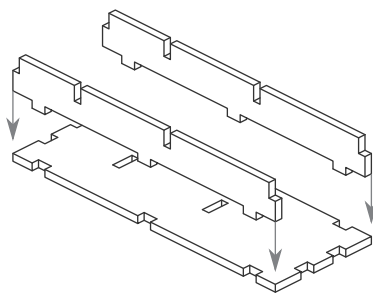

Step 2

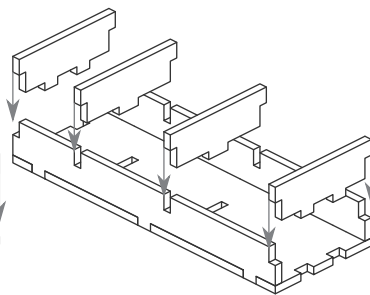

Finished tray

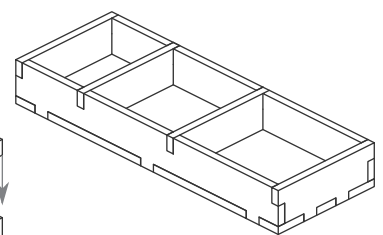

Tray 2a

Sheet B1

Sheet B2

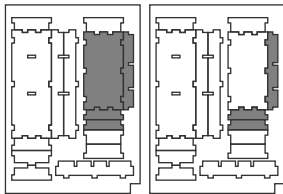

Step 1

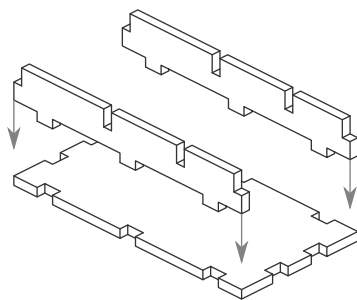

Step 2

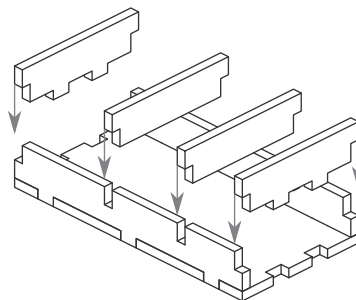

Finished tray

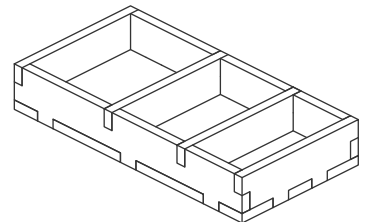

Tray 2b

Sheet B1, B2

Sheet B2

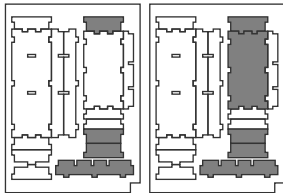

Step 1

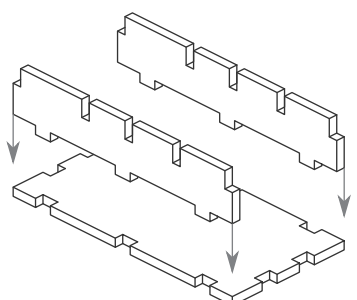

Step 2

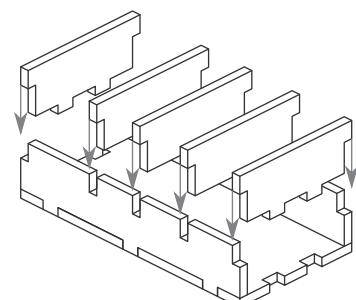

Finished tray

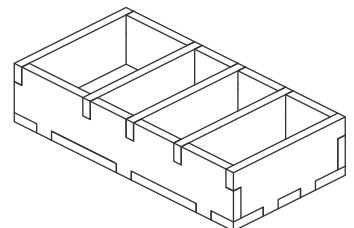

Tray 3

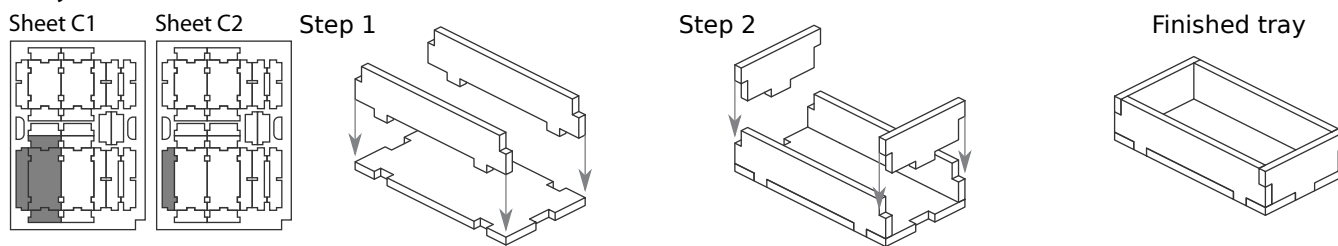

Tray 4a, 4b, 4c

(the trays are identical)

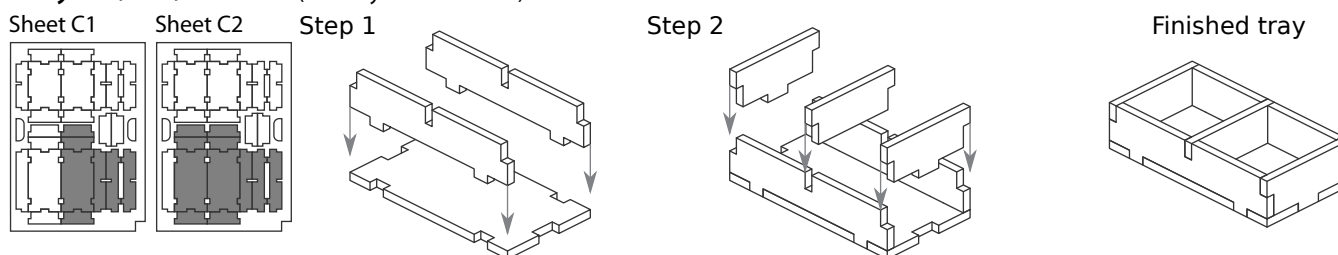

Tray 5a, 5b, 5c, 5d

(the trays are identical)

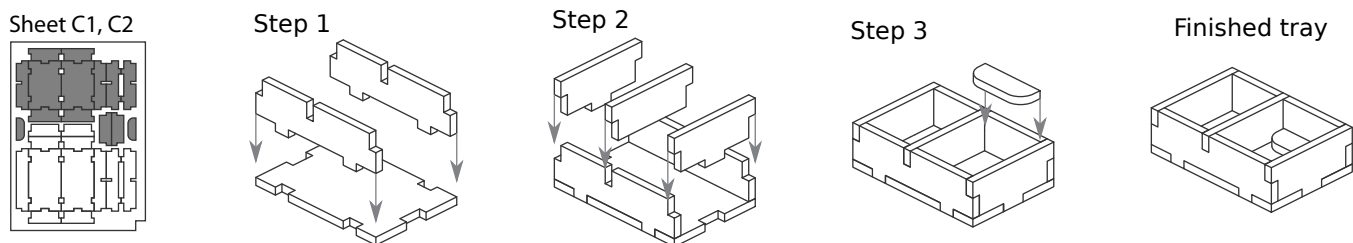

Tray 6a, 6b

(the trays are identical)

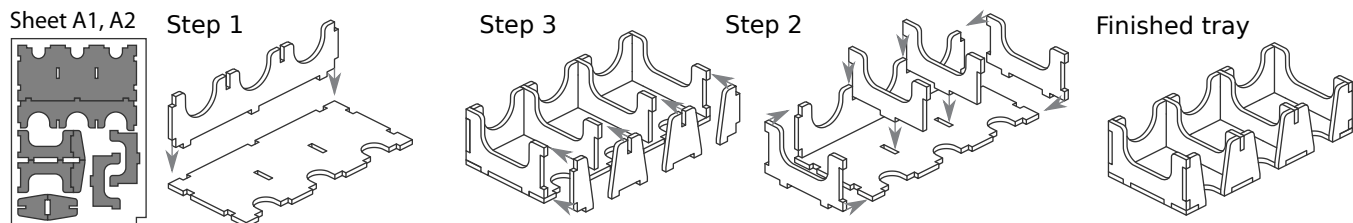

FS-ARNO

Please check www.foldedspace.net for photos of this insert in use.

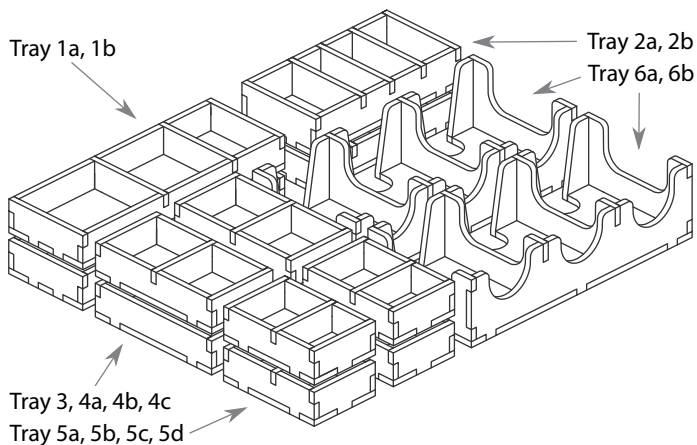

Tray legend:

- Tray 1a, b - standard enclosure and kiosk/pavilion tiles
- Tray 2a - special enclosure tiles
- Tray 2b - money tokens
- Tray 3 - unique building tiles
- Tray 4a - break, multiplier and x tokens
- Tray 4b - partner zoo and university tokens
- Tray 4c - venom, constriction and bonus tiles
- Tray 5a, b, c, d - player pieces
- Tray 6a, b - game cards

Note: Trays 6a & 6b are higher at one end. This is to hold the board in place when the box is fully loaded.