

# FS-FPUNK Insert compatible with Frostpunk® including the Frostlander expansion



## Assembly Instructions

The package contains eight sheets: 3 double and 2 single sheets.

After assembly the trays are put in up to four layers in the original game box.

Ordinary PVA glue is required when assembling each tray.

Please make sure you dry-assemble each tray correctly before gluing it together.

Please check [www.foldedspace.com](http://www.foldedspace.com) for general assembly tips.

## FS-FPUNK

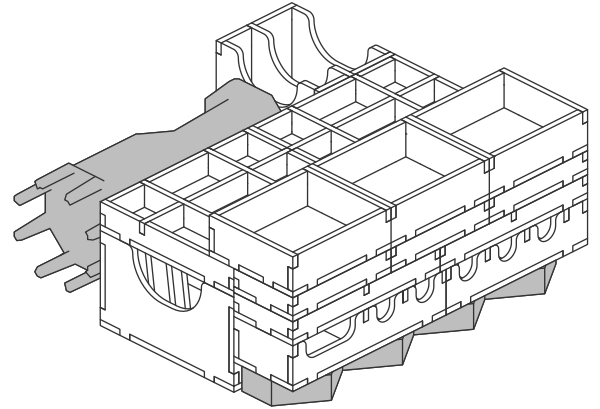

### Sheet A1, A2 Sheet B1, B2 Sheet C1, C2 Sheet D Sheet E

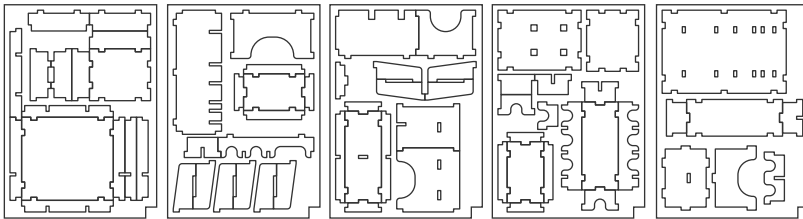

### Tray 1a, 1b (the trays are identical)

Sheet C1, C2

Step 1

Step 2

Finished trays

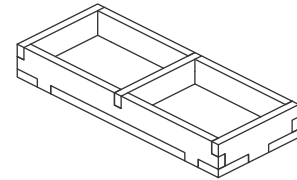
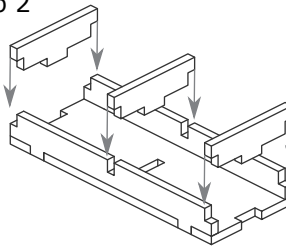
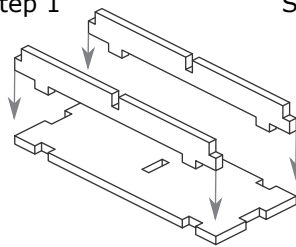
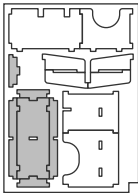

### Trays 2a, 2b, 2c, 3a, 3b, 3c

Sheet A1, A2

Sheet B1, B2

Sheet D

Step 1

Step 2

Finished trays

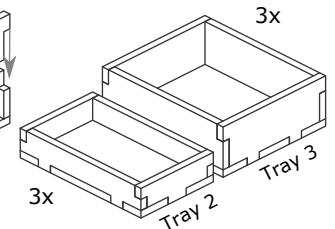
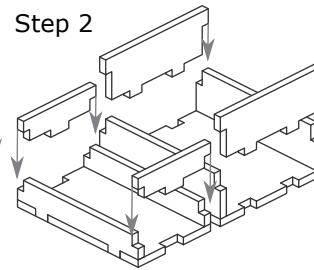
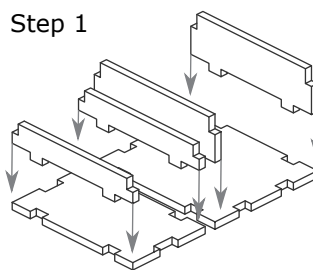
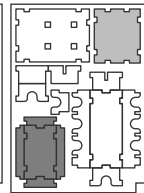
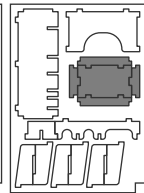
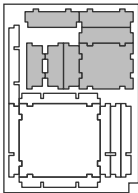

### Tray 4

Sheet C1, C2

Sheet D

Step 1

Step 2

Finished tray

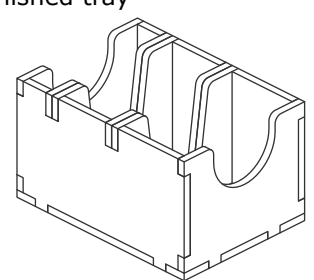
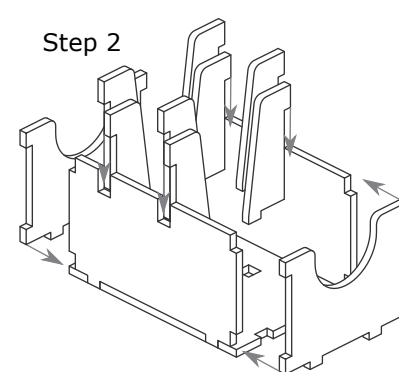
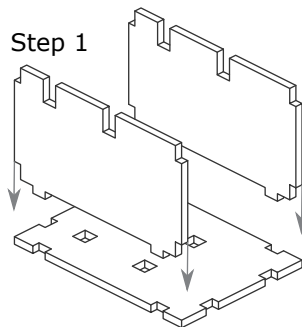
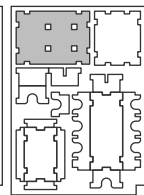
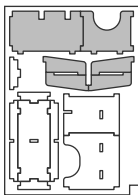

### Tray 5

Sheet C1, C2

Sheet E

Step 1

Step 2

Step 3

Finished tray

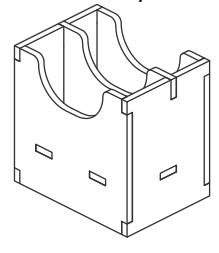
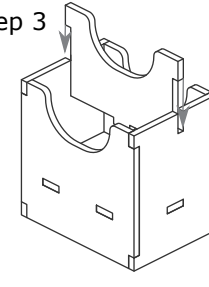
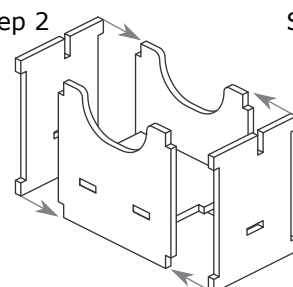
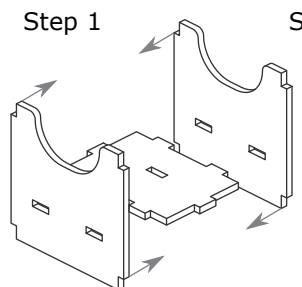
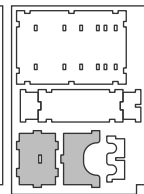
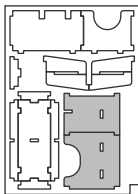

# FS-FPUNK Insert compatible with Frostpunk® including the Frostlander expansion



## Tray 6a, 6b (the trays are identical)

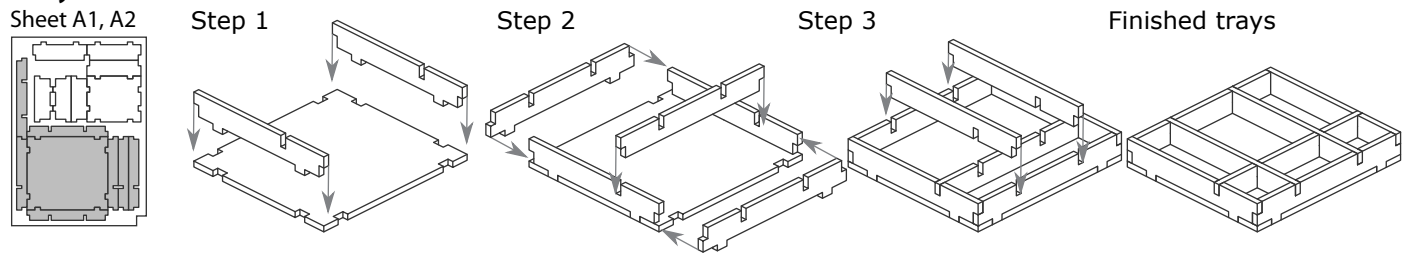

## Tray 7

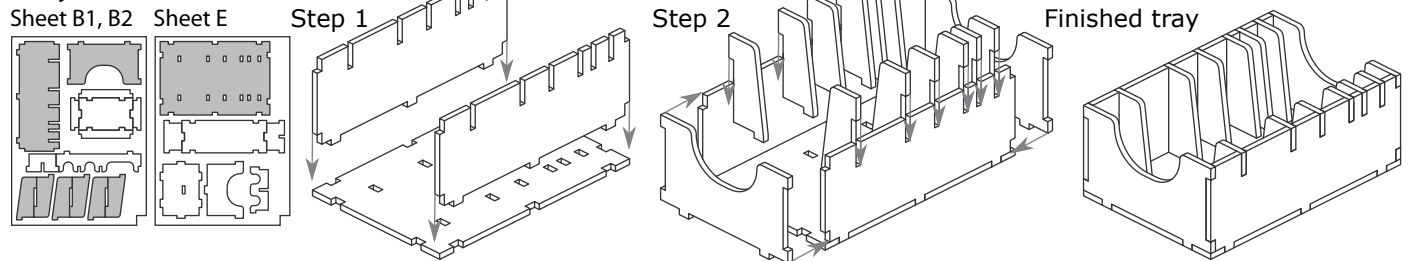

## Trays 8, 9

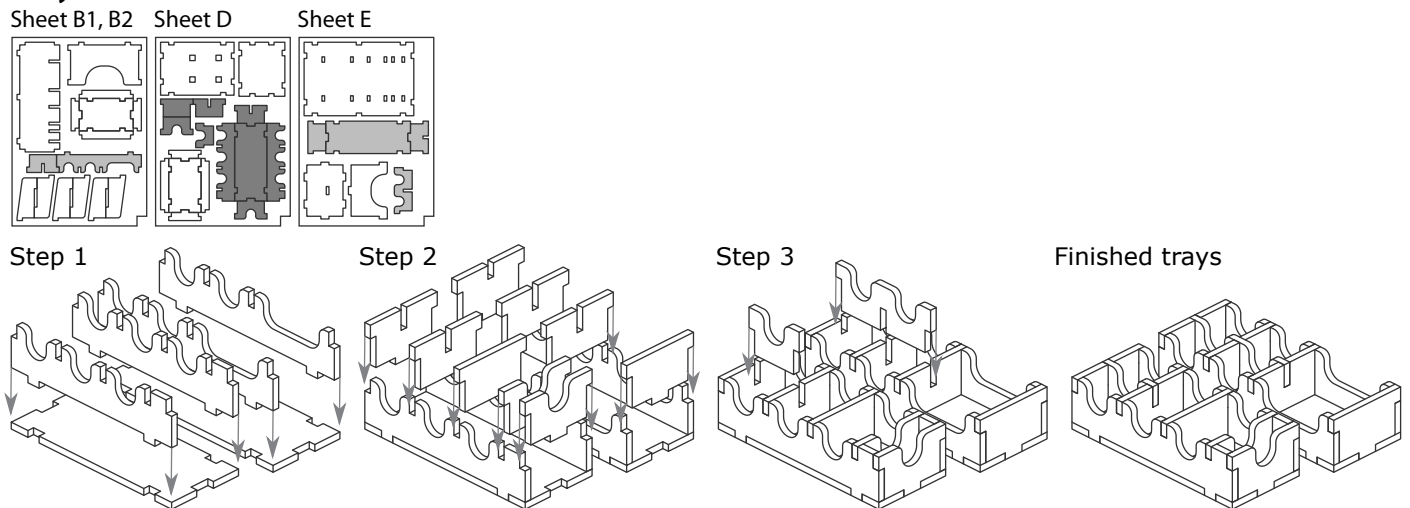

## FS-FPUNK

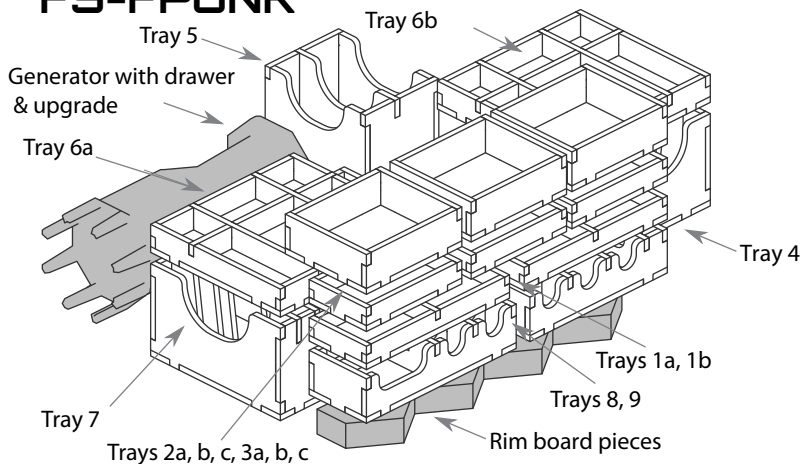

Please check [www.foldedspace.com](http://www.foldedspace.com) for photos of this insert in use.

### Tray legend

- Tray 1a - spent citizen tokens and citizen, sickness, food, hunger & feed citizen markers
- Tray 1b - green tokens, and starting wall tiles, electrostatic discharge, evacuation, and dreadnought markers
- Tray 2a, b, c - citizen meeples
- Tray 3a, b, c - discontent & hope bags with tokens inside, and other general tokens
- Tray 4 - hexagon map tiles
- Tray 5 - standard sized card decks
- Tray 6a, b - automaton meeples, wood, coal, steel, trees and steam cores
- Tray 7 - tarot sized card decks
- Trays 8, 9 - building tiles

Note: please check the product page on our website for details as to how we recommend organising your card decks and building tiles in the relevant trays. Please note also that it is important that the rim board pieces are stacked as shown in the bottom of the box.